

HELPING YOU PREVENT LOWER RESPIRATORY TRACT INFECTIONS



SOLUTIONS FOR RESPIRATORY HEALTH

Halyard Health is committed to help you reduce lower respiratory tract infections by providing effective clinical solutions to help with the removal and prevention of aspiration and colonisation in the oropharynx.

Halyard's Respiratory Health solutions bundle includes the HALYARD* Closed Suction Systems, HALYARD* MICROCUFF* Endotracheal Tubes, HALYARD* Oral Care Systems and HALYARD* Mini-BAL Sampling Catheter.

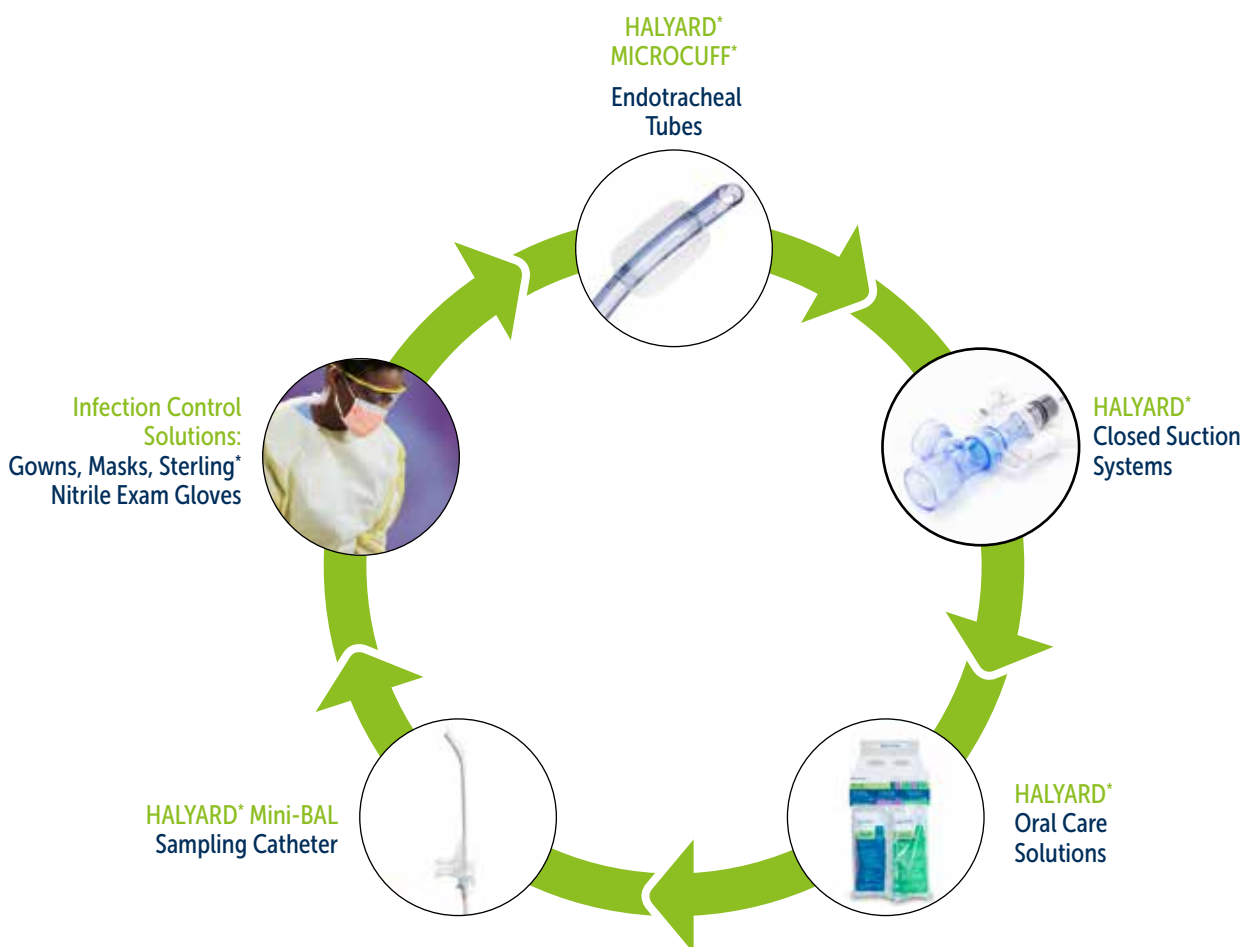

TABLE OF CONTENTS

ADULTS	5
CLOSED SUCTION SYSTEMS	5
HALYARD* TURBO-CLEANING CLOSED SUCTION SYSTEMS	5
HALYARD* Turbo-Cleaning Closed Suction System - Double Swivel Elbows	5
HALYARD* Turbo-Cleaning Closed Suction System - WET PAK* Double Swivel Elbows	7
HALYARD* Turbo-Cleaning Closed Suction System - T-Pieces	8
HALYARD* Turbo-Cleaning Closed Suction System - WET PAK* T-Pieces	8
HALYARD* MULTI -ACCESS PORT CLOSED SUCTION SYSTEMS	9
HALYARD* Multi-Access Port Closed Suction System - Double Swivel Elbows	9
HALYARD* Multi-Access Port Closed Suction System - WET PAK* Double Swivel Elbows	11
HALYARD* Multi-Access Port Closed Suction Replacement Catheter	13
HALYARD* CLOSED SUCTION SYSTEMS	14
HALYARD* Closed Suction System - T-Pieces	14
HALYARD* Closed Suction System - Double Swivel Elbows	15
HALYARD* Closed Suction System - WET PAK* T-Pieces	16
HALYARD* Closed Suction System - WET PAK* Double Swivel Elbows	17
HALYARD* CLOSED SUCTION SYSTEMS - ACCESSORIES	18
HALYARD* Multi-Access Port Closed Suction System - Accessories	18
HALYARD* Closed Suction System - Accessories	18
HALYARD* Closed Ventilator Circuit Drain	19
ENDOTRACHEAL TUBES	20
HALYARD* MICROCUFF* Subglottic Suctioning Endotracheal Tubes	20
HALYARD* MICROCUFF* Endotracheal Tubes	20
ORAL CARE SOLUTIONS	21
HALYARD* ORAL CARE KITS	21
HALYARD* Oral Care Advanced Kit	21
HALYARD* Oral Care Moderate Kit	21
HALYARD* ORAL CARE SUCTION KITS - COMPONENTS & SUCTION KITS	22
HALYARD* Oral Care Suction Kits	22
HALYARD* Oral Care Suction Components	22
HALYARD* Oral Care Swabs	23
DIAGNOSTIC CATHETERS	24
HALYARD* MINI-BAL SAMPLING CATHETER	24

NEONATES/PAEDIATRICS	25
<hr/>	
CLOSED SUCTION SYSTEMS	25
HALYARD* Closed Suction System for Neonates/Paediatics - Elbows	25
HALYARD* Closed Suction System for Neonates/Paediatics - "Y"	26
HALYARD* Multi-Access Catheter for Neonates/Paediatics	27
HALYARD* Closed Suction System for Neonates/Paediatics - Accessories	27
ENDOTRACHEAL TUBES	28
HALYARD* MICROCUFF* Endotracheal Tube for Paediatric, Oral/Nasal Magill	28
HALYARD* MICROCUFF* Endotracheal Tube for Paediatric, Oral Curved	29
ORAL CARE SOLUTIONS	30
HALYARD* Oral Care Suction Catheters for Neonates/Paediatics	30
INDEX BY CODE	31
<hr/>	

CLOSED SUCTION SYSTEMS - ADULTS

HALYARD* TURBO-CLEANING CLOSED SUCTION SYSTEMS

Indication: Aspiration catheter for removal of tracheal secretions of intubated / tracheotomized adult patients respecting the closed ventilation circuit.

HALYARD* TURBO-CLEANING CLOSED SUCTION SYSTEM - DOUBLE SWIVEL ELBOWS

- BALLARD* Technology
- Built-in Cleaning Chamber
- Gamma Sterilised: 5 Years Shelf Life
- Available for Endotracheal and Tracheostomy Tubes
- Available with Metered Dose Inhaler (MDI) Port
- Available with dual lumen catheter
- Validated for a maximum Usage Time of 72 Hours
- Does not contain Natural Rubber Latex
- Connector 15mm Female to 22mm Female

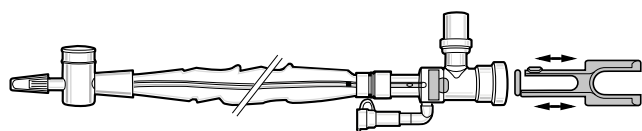

DESCRIPTION	CODE	OUTER DIAMETER	LENGTH	ISO COLOUR	PACKAGING
DOUBLE SWIVEL ELBOW Endotracheal MDI Port	2271018-5	10 Fr./3.3mm	54cm	black	20/case
DOUBLE SWIVEL ELBOW Endotracheal	227101-5	10 Fr./3.3mm	54cm	black	20/case
DOUBLE SWIVEL ELBOW Endotracheal	22716-5	12 Fr./4mm	54cm	white	20/case
DOUBLE SWIVEL ELBOW Tracheostomy	2271603-5	12 Fr./4mm	30.5cm	white	20/case
DOUBLE SWIVEL ELBOW Endotracheal MDI Port	2271218-5	12 Fr./4mm	54cm	white	20/case
DOUBLE SWIVEL ELBOW Endotracheal	227-5	14 Fr./4.6mm	54cm	green	20/case
DOUBLE SWIVEL ELBOW Tracheostomy	22703-5	14 Fr./4.6mm	30.5cm	green	20/case

All codes in **bold** indicate a sterile product

DESCRIPTION	CODE	OUTER DIAMETER	LENGTH	ISO COLOUR	PACKAGING
DOUBLE SWIVEL ELBOW Endotracheal MDI Port	2271418-5	14 Fr/4.6mm	54cm	green	20/case
DOUBLE SWIVEL ELBOW Tracheostomy MDI Port	22714183-5	14 Fr/4.6mm	30.5cm	green	20/case
DOUBLE SWIVEL ELBOW Endotracheal	227161-5	16 Fr/5.3mm	54cm	orange	20/case
DOUBLE SWIVEL ELBOW Tracheostomy	2271613-5	16 Fr/5.3mm	30.5cm	orange	20/case
DOUBLE SWIVEL ELBOW Endotracheal MDI Port	2271618-5	16 Fr/5.3mm	54cm	orange	20/case
DOUBLE SWIVEL ELBOW Tracheostomy MDI Port	22716183-5	16 Fr/5.3mm	30.5cm	orange	20/case

All codes in **bold** indicate a sterile product

HALYARD* TURBO-CLEANING CLOSED SUCTION SYSTEM - WET PAK* DOUBLE SWIVEL ELBOWS

- Contains in addition 12 Saline Vials
- Gamma Sterilised: 3 Years Shelf Life - Saline Vials: aseptically filled
- Does not contain Natural Rubber Latex
- Validated for a maximum Usage Time of 72 hours

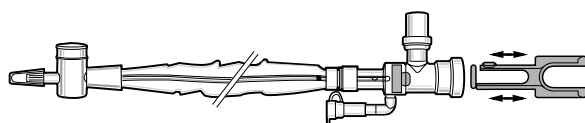

DESCRIPTION	CODE	OUTER DIAMETER	LENGTH	ISO COLOUR	PACKAGING
WET PAK* DOUBLE SWIVEL ELBOW Endotracheal	227166-5	12 Fr/4mm	54cm	white	20/case
WET PAK* DOUBLE SWIVEL ELBOW Tracheostomy	22716036-5	12 Fr/4mm	30.5cm	white	20/case
WET PAK* DOUBLE SWIVEL ELBOW Endotracheal MDI Port	22712186-5	12 Fr/4mm	54cm	white	20/case
WET PAK* DOUBLE SWIVEL ELBOW Tracheostomy MDI Port	227121863-5	12 Fr/4mm	30.5cm	white	20/case
WET PAK* DOUBLE SWIVEL ELBOW Endotracheal	2276-5	14 Fr/4.6mm	54cm	green	20/case
WET PAK* DOUBLE SWIVEL ELBOW Tracheostomy	227036-5	14 Fr/4.6mm	30.5cm	green	20/case
WET PAK* DOUBLE SWIVEL ELBOW Endotracheal MDI Port	22714186-5	14 Fr/4.6mm	54cm	green	20/case
WET PAK* DOUBLE SWIVEL ELBOW Tracheostomy MDI Port	227141863-5	14 Fr/4.6mm	30.5cm	green	20/case
WET PAK* DOUBLE SWIVEL ELBOW Endotracheal	2271616-5	16 Fr/5.3mm	54cm	orange	20/case
WET PAK* DOUBLE SWIVEL ELBOW Endotracheal MDI Port	22716186-5	16 Fr/5.3mm	54cm	orange	20/case
WET PAK* DOUBLE SWIVEL ELBOW Tracheostomy MDI Port	227161863-5	16 Fr/5.3mm	30.5cm	orange	20/case

All codes in **bold** indicate a sterile product

HALYARD* TURBO-CLEANING CLOSED SUCTION SYSTEM - T-PIECES

- Gamma Sterilised: 5 Years Shelf Life
- Does not contain Natural Rubber Latex
- Validated for a maximum Usage Time of 72 hours
- 22mm x 22mm Flex Tube Connector
- 15mm x 22mm Swivel Adapter (except 227105-5*)

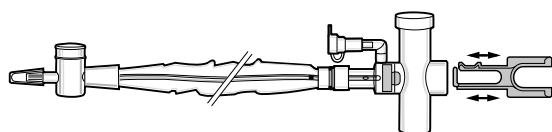

DESCRIPTION	CODE	OUTER DIAMETER	LENGTH	ISO COLOUR	PACKAGING
T-PIECE Endotracheal	227105-5*	10 Fr/3.3mm	54cm	black	20/case
T-PIECE Tracheostomy	2271053-5	10 Fr/3.3mm	30.5cm	black	20/case
T-PIECE Tracheostomy	227135-5	12 Fr/4mm	30.5cm	white	20/case
T-PIECE Tracheostomy	2271653-5	16 Fr/5.3mm	30.5cm	orange	20/case

HALYARD* TURBO-CLEANING CLOSED SUCTION SYSTEM - WET PAK* T-PIECES

- Contains in addition 12 Saline Vials
- Gamma Sterilised: 3 Years Shelf Life - Saline Vials: aseptically filled
- Validated for a maximum Usage Time of 72 hours
- Does not contain Natural Rubber Latex

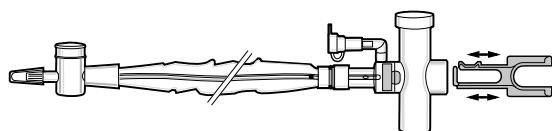

DESCRIPTION	CODE	OUTER DIAMETER	LENGTH	ISO COLOUR	PACKAGING
WET PAK* T-PIECE Endotracheal	2271516-5	12 Fr/4mm	54cm	white	20/case
WET PAK* T-PIECE Endotracheal	2270156-5	14 Fr/4.6mm	54cm	green	20/case
WET PAK* T-PIECE Tracheostomy	22701356-5	14 Fr/4.6mm	30.5cm	green	20/case
WET PAK* T-PIECE Tracheostomy	22012356-5	14 Fr/4.6mm	30.5cm	green	20/case

All codes in **bold** indicate a sterile product

HALYARD* MULTI-ACCESS PORT CLOSED SUCTION SYSTEMS

Indication: Aspiration catheter for intubated or tracheotomized adult patients who are on mechanical ventilation allowing doctors to perform alternate respiratory treatments without breaching the circuit.

HALYARD* MULTI-ACCESS PORT CLOSED SUCTION SYSTEM - DOUBLE SWIVEL ELBOWS

- BALLARD* Technology
- Built-in Cleaning Chamber
- Gamma Sterilised: 5 Years Shelf Life
- Rotational Manifold with Multiple Ports (Suctioning Port & Alternate Therapy for Bronchoscopy or HALYARD* Mini-BAL sampling catheter)
- Tethered Sleeve
- Tethered Cap
- Available for Endotracheal and Tracheostomy Tubes
- Available with Metered Dose Inhaler (MDI) Port
- Suction Catheter: Validated for a maximum Usage Time of 72 Hours
- Does not contain Natural Rubber Latex nor DEHP

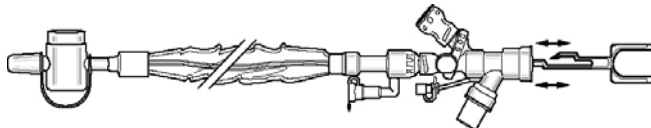

DESCRIPTION	CODE	OUTER DIAMETER	LENGTH	ISO COLOUR	PACKAGING
DOUBLE SWIVEL ELBOW Endotracheal	24010-5	10 Fr/3.3mm	58.5cm	black	20/case
DOUBLE SWIVEL ELBOW Endotracheal MDI Port	240108-5	10 Fr/3.3mm	58.5cm	black	20/case
DOUBLE SWIVEL ELBOW Endotracheal	240121-5	12 Fr/4mm	58.5cm	white	20/case
DOUBLE SWIVEL ELBOW Endotracheal MDI Port	240128-5	12 Fr/4mm	58.5cm	white	20/case
DOUBLE SWIVEL ELBOW Tracheostomy MDI Port	24001238-5	12 Fr/4mm	35cm	white	20/case
DOUBLE SWIVEL ELBOW Endotracheal	24014-5	14 Fr/4.6mm	58.5cm	green	20/case

All codes in **bold** indicate a sterile product

DESCRIPTION	CODE	OUTER DIAMETER	LENGTH	ISO COLOUR	PACKAGING
DOUBLE SWIVEL ELBOW Endotracheal MDI Port	240148-5	14 Fr/4.6mm	58.5cm	green	20/case
DOUBLE SWIVEL ELBOW Tracheostomy MDI Port	2401438-5	14 Fr/4.6mm	35cm	green	20/case
DOUBLE SWIVEL ELBOW Endotracheal MDI Port	240168-5	16 Fr/5.3mm	58.5cm	orange	20/case
DOUBLE SWIVEL ELBOW Tracheostomy MDI Port	2401638-5	16 Fr/5.3mm	35cm	orange	20/case

All codes in **bold** indicate a sterile product

HALYARD* MULTI-ACCESS PORT CLOSED SUCTION SYSTEM – WET PAK* DOUBLE SWIVEL ELBOWS

- BALLARD* Technology
- Built-in Cleaning Chamber
- Rotational Manifold with Multiple Ports (Suctioning Port & Alternate Therapy for Bronchoscopy or HALYARD* Mini-BAL sampling catheter)
- Tethered Sleeve
- Tethered Cap
- Available for Endotracheal and Tracheostomy Tubes
- Available with Metered Dose Inhaler (MDI) Port
- Contains in addition 12 Saline Vials
- Gamma Sterilised: 3 Years Shelf Life - Saline Vials: aseptically filled
- Suction Catheter: Validated for a maximum Usage Time of 72 Hours
- Does not contain Natural Rubber Latex nor DEHP

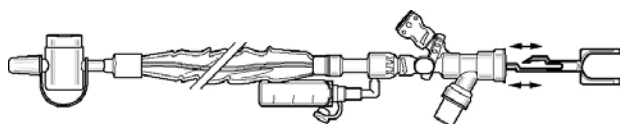

DESCRIPTION	CODE	OUTER DIAMETER	LENGTH	ISO COLOUR	PACKAGING
WET PAK* DOUBLE SWIVEL ELBOW Endotracheal	240126-5	12 Fr/4mm	58.5cm	white	20/case
WET PAK* DOUBLE SWIVEL ELBOW Tracheostomy	2401236-5	12 Fr/4mm	35cm	white	20/case
WET PAK DOUBLE SWIVEL ELBOW Endotracheal MDI Port	2401286-5	12 Fr/4mm	58.5cm	white	20/case
WET PAK* DOUBLE SWIVEL ELBOW Endotracheal	240146-5	14 Fr/4.6mm	58.5cm	white	20/case
WET PAK* DOUBLE SWIVEL ELBOW Tracheostomy	2401436-5	14 Fr/4.6mm	35cm	green	20/case
WET PAK* DOUBLE SWIVEL ELBOW Endotracheal MDI Port	2401486-5	14 Fr/4.6mm	58.5cm	green	20/case
WET PAK* DOUBLE SWIVEL ELBOW Tracheostomy MDI Port	24014386-5	14 Fr/4.6mm	35cm	green	20/case
WET PAK* DOUBLE SWIVEL ELBOW Endotracheal	240166-5	16 Fr/5.3mm	58.5cm	orange	20/case
WET PAK* DOUBLE SWIVEL ELBOW Tracheostomy	2401636-5	16 Fr/5.3mm	35cm	orange	20/case

All codes in **bold** indicate a sterile product

DESCRIPTION	CODE	OUTER DIAMETER	LENGTH	ISO COLOUR	PACKAGING
WET PAK* DOUBLE SWIVEL ELBOW Endotracheal MDI Port	2401686-5	16 Fr/5.3mm	58.5cm	orange	20/case
WET PAK* DOUBLE SWIVEL ELBOW Tracheostomy MDI Port	24016386-5	16 Fr/5.3mm	35cm	orange	20/case

All codes in **bold** indicate a sterile product

HALYARD* MULTI-ACCESS PORT CLOSED SUCTION REPLACEMENT CATHETER

- BALLARD* Technology
- Built-in Cleaning Chamber
- Gamma Sterilised: 3 Years Shelf Life
- Tethered Sleeve
- Tethered Cap
- Available for Endotracheal and Tracheostomy Tubes
- Suction Catheter: Validated for a maximum Usage Time of 72 Hours
- Does not contain Natural Rubber Latex nor DEHP

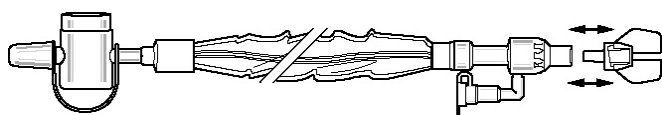

DESCRIPTION	CODE	OUTER DIAMETER	LENGTH	ISO COLOUR	PACKAGING
ENDOTRACHEAL Replacement Catheter	240125-5	12 Fr/4mm	58.5cm	white	20/case
TRACHEOSTOMY Replacement Catheter	2401253-5	12 Fr/4mm	35cm	white	20/case
ENDOTRACHEAL Replacement Catheter	240145-5	14 Fr/4.6mm	58.5cm	green	20/case
TRACHEOSTOMY Replacement Catheter	2401453-5	14 Fr/4.6mm	35cm	green	20/case
ENDOTRACHEAL Replacement Catheter	240165-5	16 Fr/5.3mm	58.5cm	orange	20/case

All codes in **bold** indicate a sterile product

HALYARD* CLOSED SUCTION SYSTEMS

Indication: Aspiration catheter for removal of tracheal secretions of intubated / tracheotomized adult patients respecting the closed ventilation circuit.

HALYARD* CLOSED SUCTION SYSTEM – T-PIECES

- BALLARD* Technology
- Tactile Sleeve for Better Feel
- Gamma Sterilised: 5 Years Shelf Life
- Locking Thumb Port
- Validated for a maximum Usage Time of 24 Hours
- 22mm x 22mm Flex Tube Connector
- Available for Endotracheal and Tracheostomy tubes
- Available with Directional Tip
- Available with Dual Lumen Catheter
- Does not contain Natural Rubber Latex

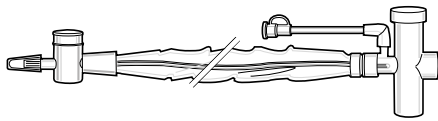

DESCRIPTION	CODE	OUTER DIAMETER	LENGTH	ISO COLOUR	PACKAGING
CLEAR T-PIECE Endotracheal	2205-5	14 Fr/4.6mm	54cm	green	20/case
CLEAR T-PIECE Tracheostomy 15mm x 22mm Swivel Adapter	220135-5	14 Fr/4.6mm	30.5cm	green	20/case
CLEAR T-PIECE Endotracheal 15mm x 22mm Swivel Adapter	22515-5	16 Fr/5.3mm	54cm	orange	20/case

All codes in **bold** indicate a sterile product

HALYARD* CLOSED SUCTION SYSTEM – DOUBLE SWIVEL ELBOWS

- BALLARD* Technology
- Tactile Sleeve for Better Feel
- Numbered Catheter Allowing the Clinician to Limit the Distance of Catheter Advance
- Gamma Sterilised: 5 Years Shelf Life
- Available for Endotracheal and Tracheostomy tubes
- Available with Dual Lumen Catheter
- Available with Directional Tip
- Connector 15mm Female to 22mm Female
- Validated for a maximum Usage Time of 24 Hours
- Does not contain Natural Rubber Latex

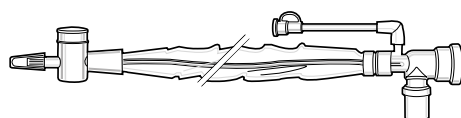

DESCRIPTION	CODE	OUTER DIAMETER	LENGTH	ISO COLOUR	PACKAGING
DOUBLE SWIVEL ELBOW Tracheostomy	21603-5	12 Fr/4mm	30.5cm	white	20/case
DOUBLE SWIVEL ELBOW Endotracheal Directional Tip	21609-5	12 Fr/4mm	56cm	white	20/case
DOUBLE SWIVEL ELBOW Tracheostomy	22103-5	14 Fr/4.6mm	30.5cm	green	20/case
DOUBLE SWIVEL ELBOW Endotracheal Dual Lumen	22107-5	14 Fr/4.6mm	54cm	green	20/case
DOUBLE SWIVEL ELBOW Endotracheal MDI Port	22108-5	14 Fr/4.6mm	54cm	green	20/case
DOUBLE SWIVEL ELBOW Endotracheal Directional Tip	22109-5	14 Fr/4.6mm	56cm	green	20/case
DOUBLE SWIVEL ELBOW Endotracheal	2260-5	16 Fr/5.3mm	54cm	orange	20/case

All codes in **bold** indicate a sterile product

HALYARD* CLOSED SUCTION SYSTEM – WET PAK* T-PIECES

- BALLARD* Technology
- Gamma Sterilised: 3 Years Shelf Life - Saline Vials: aseptically filled
- Tactile Sleeve for Better Feel
- Contains in addition 12 Saline Vials and a 22mm x 22mm Flex Tube Connector
- Available with MDI Port
- Available with Directional Tip
- Validated for a maximum Usage Time of 24 Hours
- Does not contain Natural Rubber Latex

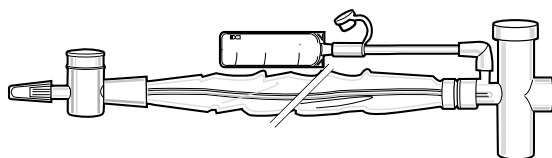

DESCRIPTION	CODE	OUTER DIAMETER	LENGTH	ISO COLOUR	PACKAGING
WET PAK* CLEAR T-PIECE Endotracheal Directional Tip	220569-5	14 Fr/4.6mm	56cm	green	20/case
WET PAK* CLEAR T-PIECE Endotracheal MDI Port	220568-5	14 Fr/4.6mm	54cm	green	20/case

All codes in **bold** indicate a sterile product

HALYARD* CLOSED SUCTION SYSTEM – WET PAK* DOUBLE SWIVEL ELBOWS

- BALLARD* Technology
- Gamma Sterilised: 3 Years Shelf Life - Saline Vials: aseptically filled
- Tactile Sleeve for Better Feel
- Contains in addition 12 Saline Vials
- Validated for a maximum Usage Time of 24 Hours
- Does not contain Natural Rubber Latex

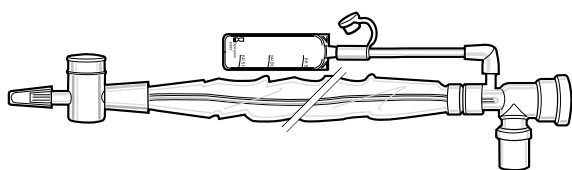

DESCRIPTION	CODE	OUTER DIAMETER	LENGTH	ISO COLOUR	PACKAGING
WET PAK* DOUBLE SWIVEL ELBOW Endotracheal	21606-5	12 Fr/4mm	54cm	white	20/case
WET PAK* DOUBLE SWIVEL ELBOW Tracheostomy	216036-5	12 Fr/4mm	30.5cm	white	20/case
WET PAK* DOUBLE SWIVEL ELBOW Endotracheal	22106-5	14 Fr/4.6mm	54cm	green	20/case
WET PAK* DOUBLE SWIVEL ELBOW Tracheostomy	221036-5	14 Fr/4.6mm	30.5cm	green	20/case
WET PAK* DOUBLE SWIVEL ELBOW Endotracheal Directional Tip	221069-5	14 Fr/4.6mm	56cm	green	20/case
WET PAK* DOUBLE SWIVEL ELBOW Tracheostomy MDI Port	2210386-5	14 Fr/4.6mm	30.5cm	green	20/case
WET PAK* DOUBLE SWIVEL ELBOW Endotracheal	22606-5	16 Fr/5.3mm	54cm	orange	20/case

All codes in **bold** indicate a sterile product

HALYARD* CLOSED SUCTION SYSTEMS - ACCESSORIES

HALYARD* MULTI-ACCESS PORT CLOSED SUCTION SYSTEM – ACCESSORIES

- Gamma Sterilised



DESCRIPTION	CODE	PACKAGING
HALYARD* SEAL CASSETTE	24013-5	20/case

HALYARD* CLOSED SUCTION SYSTEM - ACCESSORIES

- Gamma Sterilised

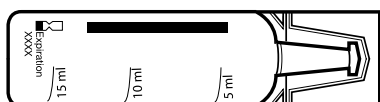

118

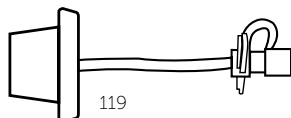

DESCRIPTION	CODE	PACKAGING
FLEX TUBE, 22MM X 22MM	113	20/case
Y-ADAPTER FOR SUCTION CANISTER	114	50/case
UNIT DOSE SALINE, 0.9% SODIUM CHLORIDE SOLUTION, PINK VIAL, 15ML, NONPYROGENIC, ASEPTICALLY FILLED	118	144/case
CONNECTOR 15MM FEMALE TO 22MM FEMALE	1115	50/case
SWIVEL ADAPTER, 15MM X 22MM, T-PIECE	111	50/case
FIXED ADAPTER, 15MM X 22MM, T-PIECE	112	50/case
METERED DOSE INHALER ADAPTER	119	20/case
BLUE ADAPTER FOR HALYARD* CLOSED SUCTION SYSTEM	50040	20/case

All codes in **bold** indicate a sterile product

HALYARD* CLOSED VENTILATOR CIRCUIT DRAIN

- Allows the Clearing of Ventilator Condensation Without Exposing the Caregiver or the Patient
- Vacuum Activated
- Maintains a Closed System
- Developed With the Safety of the Caregiver and Patient in Mind

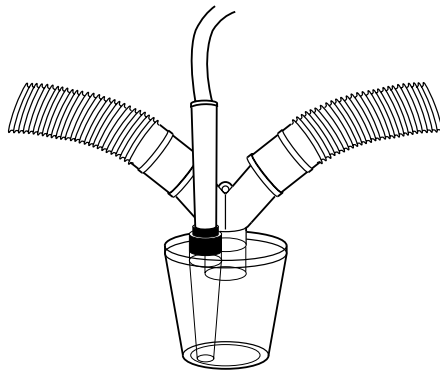

DESCRIPTION	CODE	PACKAGING
HALYARD* CLOSED VENTILATOR CIRCUIT DRAIN ONLY	131	50/case
HALYARD* CLOSED VENTILATOR CIRCUIT DRAIN KIT:	132	25/case
Circuit Drain 2,74 m Connector Tubing Y-Adapter		
HALYARD* CLOSED VENTILATOR CIRCUIT DRAIN PROBE	133	50/case
2,74 m Connector Tubing Y-Adapter		
HALYARD* CLOSED VENTILATOR CIRCUIT DRAIN WITH 90 DEGREE CONNECTION	134	25/case
2,74 m Connector Tubing Collapsible Connector Y-Adapter		

All codes in **bold** indicate a sterile product

ENDOTRACHEAL TUBES - ADULTS

Indication: Airway management by nasal or oral intubation of the trachea in adult patients

- Oral/Nasal Magill
- Helps to prevent micro-aspiration
- Sealed airway at very low cuff pressure
- EO Sterilised: 5 Years Shelf Life
- Radio-opaque
- Anatomically-based Intubation Depth Mark
- Murphy Eye
- Does not contain Natural Rubber Latex

HALYARD* MICROCUFF* SUBGLOTTIC SUCTIONING ENDOTRACHEAL TUBES

- Available in sizes 7.0 to 9.0 mm (inner diameter)
- Cylindrical polyurethane ultra-thin cuff
- DEHP free

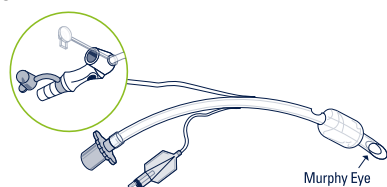

TUBE SIZE (INNER DIAMETER)	CODE	PACKAGING
7.0 MM	13220	1 case – 10 eaches/dispenser
7.5 MM	13221	1 case – 10 eaches/dispenser
8.0 MM	13222	1 case – 10 eaches/dispenser
8.5 MM	13223	1 case – 10 eaches/dispenser
9.0 MM	13224	1 case – 10 eaches/dispenser

HALYARD* MICROCUFF* ENDOTRACHEAL TUBES

- Available in sizes 5.0 to 10.0 mm (inner diameter)
- Cylindrical Cuff



TUBE SIZE (INNER DIAMETER)	CODE	PACKAGING
5.0 MM	35210	1 case – 10 eaches/dispenser
5.5 MM	35211	1 case – 10 eaches/dispenser
6.0 MM	35212	1 case – 10 eaches/dispenser
6.5 MM	35213	1 case – 10 eaches/dispenser
7.0 MM	35214	1 case – 10 eaches/dispenser
7.5 MM	35215	1 case – 10 eaches/dispenser
8.0 MM	35216	1 case – 10 eaches/dispenser
8.5 MM	35217	1 case – 10 eaches/dispenser
9.0 MM	35218	1 case – 10 eaches/dispenser
10.0 MM	35220	1 case – 10 eaches/dispenser

All codes in **bold** indicate a sterile product

ORAL CARE SOLUTIONS - ADULTS

HALYARD* ORAL CARE KITS

Indication: Suction tools for removal of oral secretions of patients, that support the compliance to a comprehensive oral care protocol.



HALYARD* ORAL CARE ADVANCED KIT

- 2 Years Shelf Life

Kit Includes:

- 1 Prep pack (incl. 1 covered Yankauer, 1 Y-adapter & 1 suction handle)
- 4 Suction Swab Packs (incl. 1 suction swab, 1 applicator swab & 1 empty solution cup)
- 2 Toothbrush Packs (incl. 1 suction toothbrush, 1 oral swab & 1 empty solution cup)

DESCRIPTION	CODE	PACKAGING
HALYARD* ORAL CARE ADVANCED KIT	25928	24/case

HALYARD* ORAL CARE MODERATE KIT

- 2 Years Shelf Life

Kit includes:

- 1 Prep Pack (incl. 1 covered Yankauer, 1 Y-adapter & 1 suction handle)
- 2 Suction Swab Packs (incl. 1 suction swab, 1 applicator swab & 1 empty solution cup)
- 1 Toothbrush Pack (incl. 1 suction toothbrush, 1 oral swab & 1 empty solution cup)

DESCRIPTION	CODE	PACKAGING
HALYARD* ORAL CARE MODERATE KIT	25930	32/case

All codes in **bold** indicate a sterile product

HALYARD* ORAL CARE SUCTION KITS - COMPONENTS & SUCTION KITS

Indication: Suction tools for removal of oral secretions of patients, that support the compliance to a comprehensive oral care protocol.

HALYARD* ORAL CARE SUCTION KITS

- 2 Years Shelf Life

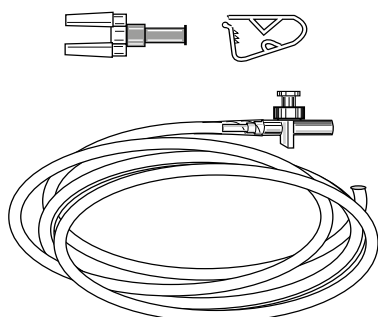

DESCRIPTION	CODE	PACKAGING
HALYARD* CONNECTION TUBING WITH SUCTION VALVE:	122	50/case
1 suction valve, 2,74 m funnel tubing 1 suction line clamp, 1 Y-adaptor		

HALYARD* ORAL CARE SUCTION COMPONENTS

- 5 Years Shelf Life (except 99785*, 99786*, 99789*: 2 Years Shelf Life)

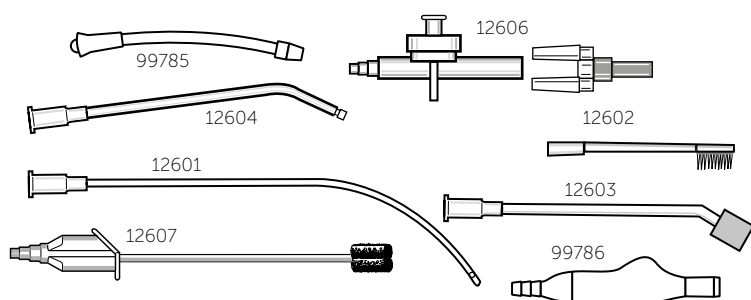

DESCRIPTION	CODE	PACKAGING
HALYARD* READY CARE* ORAL CARE SUCTION PROBES	123	50/case
HALYARD* ORAL CARE SUCTION CATHETER FOR ADULTS	12601	25/case
HALYARD* ORAL CARE SUCTION TOOTHBRUSH	12602	25/case
HALYARD* ORAL CARE SUCTION SWAB, ANGLED-TIP	12603	25/case
HALYARD* ORAL CARE SUCTION TIP YANKAUER	12604	25/case
HALYARD* SUCTION VALVE AND Y-ADAPTER	12606	25/case

All codes in **bold** indicate a sterile product

DESCRIPTION	CODE	PACKAGING
HALYARD* ORAL CARE SUCTION SWAB, WITH DENTIFRICE (MAY BE USED WITHOUT HALYARD* SUCTION VALVE)	12607	25/case
HALYARD* SELF-CLEANING COVERED YANKAUER	99785*	25/case
HALYARD* SUCTION HANDLE	99786*	25/case
HALYARD* ORAL CARE PREP PACK: 1 self-cleaning, covered Yankauer, 1 suction handle, Y-adapter	99789*	40/case

HALYARD* ORAL CARE SWABS

- Shelf Life for Swabs with Dentifrice: 2 years
- Shelf Life for Swabs without Dentifrice: 5 years

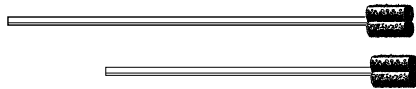

DESCRIPTION	CODE	ITEMS/POUCH	POUCHES/CASE
SINGLE WRAPPED			
HALYARD* ORAL CARE SWAB	12240	250	4
HALYARD* ORAL CARE SWAB, WITH DENTIFRICE	12245	250	4
HALYARD* ORAL CARE SWAB, WITH DENTIFRICE	12246	250	2
HALYARD* ORAL CARE SWAB, PLASTIC HANDLE	12254	250	4
HALYARD* ORAL CARE SWAB, WITH DENTIFRICE, PLASTIC HANDLE	12255	250	4
BULK PACKAGED			
HALYARD* ORAL CARE SWAB	12241	500	2
HALYARD* ORAL CARE SWAB	12243	20	50
HALYARD* ORAL CARE SWAB, WITH DENTIFRICE	12247	10	100
HALYARD* ORAL CARE SWAB, WITH DENTIFRICE	12249	20	50
HALYARD* ORAL CARE SWAB, PLASTIC HANDLE	12251	20	50
HALYARD* ORAL CARE SWAB, WITH DENTIFRICE, PLASTIC HANDLE	12257	20	50

All codes in **bold** indicate a sterile product

DIAGNOSTIC CATHETERS - ADULTS

HALYARD* MINI-BAL SAMPLING CATHETER

Indication: This product is intended for early, accurate diagnosis of VAP.

- Simple, effective non-bronchoscopic bronchoalveolar lavage at the bedside
- EO Sterilised: 3 Years Shelf Life
- Directional Tip for R/L Insertion
- Includes an access port elbow, adapter for seal cassette, seal cassette, stepped connector, oxygen line
- Atraumatic "Mushroom" Tip
- Does not contain Natural Rubber Latex

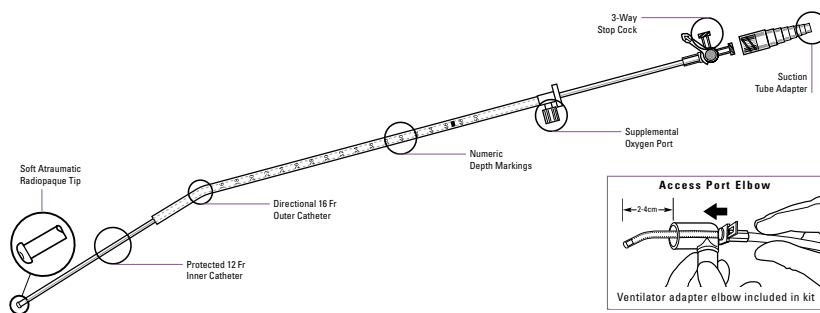

DESCRIPTION	CODE	PACKAGING
HALYARD* MINI-BAL SAMPLING CATHETER – 16 FR OUTER/12 FR INNER TELESCOPING CATHETER	142	5/case
HALYARD* MINI-BAL SAMPLING CATHETER – 13 FR OUTER/8 FR INNER TELESCOPING CATHETER	143	5/case

All codes in **bold** indicate a sterile product

CLOSED SUCTION SYSTEMS - NEONATES/PAEDIATRICS

Indication: Aspiration catheter for removal of tracheal secretions of intubated neonatal/paediatric patients respecting the closed ventilation circuit.

HALYARD* CLOSED SUCTION SYSTEM FOR NEONATES/PAEDIATRICS - ELBOWS

- BALLARD* Technology
- Gamma Sterilised: 5 Years Shelf Life
- Locking Thumb Port
- Contains Elbow Adapters
- Does not contain Natural Rubber Latex
- The Catheter is DEHP free



DESCRIPTION	CODE	OUTER DIAMETER	LENGTH	ISO COLOUR	PACKAGING
ELBOW ENDOTRACHEAL TUBE ADAPTERS (2.5mm, 3mm, 3.5mm)	206-5	6 Fr/2mm	30.5cm	light green	20/case
ELBOW ENDOTRACHEAL TUBE ADAPTERS (2.5mm, 3mm, 3.5mm, 4mm)	207-5	7 Fr/2.3mm	35.5cm	ivory	20/case
ELBOW ENDOTRACHEAL TUBE ADAPTERS (3mm, 3.5mm, 4mm)	208-5	8 Fr/2.6mm	35.5cm	light blue	20/case
ELBOW ENDOTRACHEAL TUBE ADAPTERS (4.5mm, 5mm, 5.5mm)	210-5	10 Fr/3.3mm	40.5cm	black	20/case

All codes in **bold** indicate a sterile product

HALYARD* CLOSED SUCTION SYSTEM FOR NEONATES/PAEDIATRICS - "Y"

- BALLARD* Technology
- Gamma Sterilised: 5 Years Shelf Life
- Locking Thumb Port
- Contains Elbow and Y-adapters
- Does not contain Natural Rubber Latex
- The Catheter is DEHP free



DESCRIPTION	CODE	OUTER DIAMETER	LENGTH	ISO COLOUR	PACKAGING
"Y" ENDOTRACHEAL TUBE ADAPTERS (2mm, 2.5mm)	195-5	5 Fr/1.6mm	30.5cm	grey	20/case
"Y" ENDOTRACHEAL TUBE ADAPTERS (2.5mm, 3mm, 3.5mm)	196-5	6 Fr/2mm	30.5cm	light green	20/case
"Y" ENDOTRACHEAL TUBE ADAPTERS (3mm, 3.5mm, 4mm)	197-5	7 Fr/2.3mm	30.5cm	ivory	20/case
"Y" ENDOTRACHEAL TUBE ADAPTERS (3mm, 3.5mm, 4mm)	198-5	8 Fr/2.6mm	30.5cm	light blue	20/case
"Y" ENDOTRACHEAL TUBE ADAPTERS (4.5mm, 5mm, 5.5mm)	1910-5	10 Fr/3.3mm	40.5cm	black	20/case
"Y" ENDOTRACHEAL TUBE ADAPTERS (5.5mm, 6mm, 6.5mm)	1912-5	12 Fr/4mm	40.5cm	white	20/case

All codes in **bold** indicate a sterile product

HALYARD* MULTI-ACCESS CATHETER FOR NEONATES/PAEDIATRICS

Indication: A multi-access catheter designed to deliver surfactants to the distal airway

- BALLARD* Technology
- Gamma Sterilised: 5 Years Shelf Life
- Contains Closure Cap and Y-adapter
- Does not contain Natural Rubber Latex
- The Catheter is DEHP free

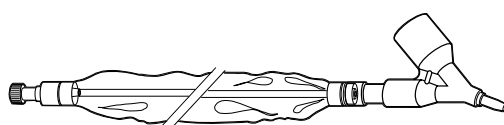

DESCRIPTION	CODE	OUTER DIAMETER	LENGTH	ISO COLOUR	PACKAGING
MAC CATHETER ADAPTER (2.5mm, 3mm, 3.5mm)	1900	5 Fr/1.6mm	30.5cm	white	5/case
MAC CATHETER ADAPTER (2mm)	1920	5 Fr/1.6mm	30.5cm	white	5/case
MAC CATHETER ADAPTER (4mm)	1940	5 Fr/1.6mm	30.5cm	white	5/case
TRANSPORT KIT ("Y" Plug and Cap)	19000				50/case

HALYARD* CLOSED SUCTION SYSTEM FOR NEONATES/PAEDIATRICS - ACCESSORIES



DESCRIPTION	CODE	PACKAGING
ENDOTRACHEAL TUBE ADAPTER 2MM WITH LAVAGE PORT	2-020	20/case
ENDOTRACHEAL TUBE ADAPTER 2.5MM WITH LAVAGE PORT	2-025	20/case
ENDOTRACHEAL TUBE ADAPTER 3MM WITH LAVAGE PORT	2-030	20/case
ENDOTRACHEAL TUBE ADAPTER 3.5MM WITH LAVAGE PORT	2-035	20/case
ENDOTRACHEAL TUBE ADAPTER 4MM WITH LAVAGE PORT	2-040	20/case
ENDOTRACHEAL TUBE ADAPTER 4.5MM WITH LAVAGE PORT	2-045	20/case
MANUAL PERCUSSOR FOR NEONATAL PULMONARY USE	11000	12/case

All codes in **bold** indicate a sterile product

ENDOTRACHEAL TUBES - PAEDIATRICS

Indication: Airway management by nasal or oral intubation of the trachea in paediatric patients

- Available in Magill & RAE / preformed types
- Available in sizes 3.0 to 7.0 mm (inner diameter)
- EO Sterilised: 5 Years Shelf Life
- Designed for ideal anatomic cuff placement
- Sealed airway at ultra low cuff pressure
- Does not contain Natural Rubber Latex

HALYARD* MICROCUFF* ENDOTRACHEAL TUBE FOR PAEDIATRIC, ORAL/NASAL MAGILL

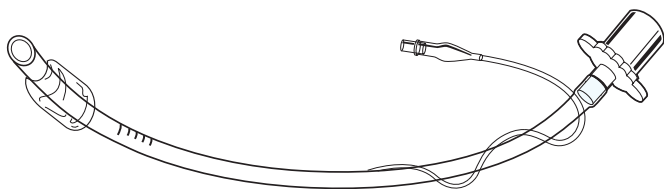

TUBE SIZE (INNER DIAMETER)	CODE	AGE/WEIGHT YEARS/KG	PACKAGING
3.0 MM	35111	Term \geq 3kg to < 8 months	10/dispenser
3.5 MM	35112	8 months < 2 years	10/dispenser
4.0 MM	35113	2 to < 4 years	10/dispenser
4.5 MM	35114	4 to < 6 years	10/dispenser
5.0 MM	35115	6 to < 8 years	10/dispenser
5.5 MM	35116	8 to < 10 years	10/dispenser
6.0 MM	35117	10 to < 12 years	10/dispenser
6.5 MM	35118	12 to < 14 years	10/dispenser
7.0 MM	35119	14 to < 16 years	10/dispenser

All codes in **bold** indicate a sterile product

HALYARD* MICROCUFF* ENDOTRACHEAL TUBE FOR PAEDIATRIC, ORAL CURVED

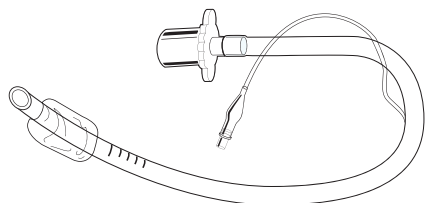

TUBE SIZE (INNER DIAMETER)	CODE	AGE/WEIGHT YEARS/KG	PACKAGING
3.0 MM	35161	Term \geq 3kg to < 8 months	10/dispenser
3.5 MM	35162	8 months < 2 years	10/dispenser
4.0 MM	35163	2 to < 4 years	10/dispenser
4.5 MM	35164	4 to < 6 years	10/dispenser
5.0 MM	35165	6 to < 8 years	10/dispenser
5.5 MM	35166	8 to < 10 years	10/dispenser
6.0 MM	35167	10 to < 12 years	10/dispenser
6.5 MM	35168	12 to < 14 years	10/dispenser
7.0 MM	35169	14 to < 16 years	10/dispenser

All codes in **bold** indicate a sterile product

ORAL CARE SOLUTIONS - NEONATES/PAEDIATRICS

HALYARD* ORAL CARE SUCTION CATHETERS FOR NEONATES/PAEDIATRICS

- Does not contain Natural Rubber Latex

DESCRIPTION	CODE	PACKAGING
5 HALYARD* ORAL CARE SUCTION CATHETERS FOR NEONATES/PAEDIATRICS (6 Fr - 2 mm)	1221	50/case
5 HALYARD* ORAL CARE SUCTION CATHETERS FOR NEONATES/PAEDIATRICS (8 Fr - 2.6 mm)	1222	50/case
5 HALYARD* ORAL CARE SUCTION CATHETERS FOR NEONATES/PAEDIATRICS (10 Fr - 3.3 mm)	1223	50/case

All codes in **bold** indicate a sterile product

INDEX BY CODE

CODE	PAGE	CODE	PAGE	CODE	PAGE	CODE	PAGE
2-020	27	12243	23	35117	28	240146-5	11
2-025	27	12245	23	35118	28	240148-5	10
2-030	27	12246	23	35119	28	240165-5	13
2-035	27	12247	23	35161	29	240166-5	11
2-040	27	12249	23	35162	29	240168-5	10
2-045	27	12251	23	35163	29	2210386-5	17
111	18	12254	23	35164	29	2270156-5	8
112	18	12255	23	35165	29	2271018-5	5
113	18	12257	23	35166	29	2271053-5	8
114	18	12601	22	35167	29	2271218-5	5
118	18	12602	22	35168	29	2271418-5	6
119	18	12603	22	35169	29	2271516-5	8
122	22	12604	22	35210	20	2271603-5	5
123	22	12606	22	35211	20	2271613-5	6
131	19	12607	23	35212	20	2271616-5	7
132	19	13220	20	35213	20	2271618-5	6
133	19	13221	20	35214	20	2271653-5	8
134	19	13222	20	35215	20	2401236-5	11
142	24	13223	20	35216	20	2401253-5	13
143	24	13224	20	35217	20	2401286-5	11
195-5	26	19000	27	35218	20	2401436-5	11
196-5	26	21603-5	15	35220	20	2401438-5	10
197-5	26	21606-5	17	50040	18	2401453-5	13
198-5	26	21609-5	15	99785	23	2401486-5	11
206-5	25	22103-5	15	99786	23	2401636-5	11
207-5	25	22106-5	17	99789	23	2401638-5	10
208-5	25	22107-5	15	216036-5	17	2401686-5	12
210-5	25	22108-5	15	220135-5	14	22012356-5	8
227-5	5	22109-5	15	220568-5	16	22701356-5	8
1115	18	22515-5	14	220569-5	16	22712186-5	7
1221	30	22606-5	17	221036-5	17	22714183-5	6
1222	30	22703-5	5	221069-5	17	22714186-5	7
1223	30	22716-5	5	227036-5	7	22716036-5	7
1900	27	24010-5	9	227101-5	5	22716183-5	6
1910-5	26	24013-5	18	227105-5	8	22716186-5	7
1912-5	26	24014-5	9	227135-5	8	24001238-5	9
1920	27	25928	21	227161-5	6	24014386-5	11
1940	27	25930	21	227166-5	7	24016386-5	12
2205-5	14	35111	28	240108-5	9	227121863-5	7
2260-5	15	35112	28	240121-5	9	227141863-5	7
2276-5	7	35113	28	240125-5	13	227161863-5	7
11000	27	35114	28	240126-5	11		
12240	23	35115	28	240128-5	9		
12241	23	35116	28	240145-5	13		

Halyard Health is a medical technology company focused on advancing health and healthcare by delivering clinically-superior products and solutions in infection prevention, surgical solutions, respiratory health, digestive health, IV therapy, and pain management. Halyard sells its recognised brands and products in more than 100 countries and holds leading market positions in multiple categories across the portfolio.



Clinically Superior Products

Our products and solutions are high performance and high quality, and can be trusted to deliver optimal patient outcome.

Remarkable Service

We truly care about our customers and their patients, going the extra mile to ensure they have the support they need, when they need it.

Deep Expertise

We are experts in prevention and healing and recovery. We leverage that expertise to guide and problem-solve with our customers.

Purposeful Innovation

We create new-to-the-world innovations that meet and anticipate the dynamic needs of our customers and patients.

For more information, please contact your Halyard Customer Care Team :

Tel: 0800 917 65 85 (from UK & IE only)

Fax: 0800 169 02 35 (from UK & IE only)

customerservice.uk.ie@hyh.com

From other countries:

Tel: +32 2 700 68 51

Fax: +32 2 711 26 91

customerservice.export@hyh.com

